



Description

The Flex Synergy 6 7585 is a cutting-edge powered horizontal speaker expertly crafted for perfect synergy with compact conferencing cameras. Tailored specifically for the Huddly L1 camera, it ensures superior audio projection in larger spaces that fully utilize the L1's capabilities. Importantly, it is compatible with a wide range of other compact camera models, making it a versatile choice for any setting. The Synergy 6 7585 not only enhances audio clarity but also reduces distortion, providing an expansive frequency response that guarantees a seamless and engaging conferencing experience.

The Flex Synergy 6 7585 loudspeaker system consists of a sealed, equalized low-frequency module with dual low-profile 6.0" drivers and a mid/high-frequency module featuring two proprietary 3.5" Innovox drivers and an Air Motion Transformer (AMT). This combination significantly boosts clarity, transient response, and musical finesse, enriching the audio experience in any environment.

For larger setups or stereo applications, multiple systems can be easily combined, making it ideal for dual displays or direct-view LED walls.

Key Features

- Dimension matched
- High performance three-way design
- Plug-n-Play with included DSP and speaker processing
- Slim profile - ADA compliant
- Available in a variety of finishes
- Optional  Dante

Applications

- Premium conferencing rooms
- High resolution audio for video displays 75.00" - 85.00"
- Program audio in large conferencing / training rooms
- Higher Education
- Corporate gathering spaces
- Command and control centers

Nominal Data

Frequency Response	60Hz–20KHz +/- 2.5dB ¹
Amplifier	2 x 200w with dsp ²
Max Long-Term SPL	109dB
Max Peak SPL	115dB
Dimensions (HxWxL)	6.63" [168.4mm] x 3.25" [82.6mm] x 75" - 85" [1905 - 2159mm]
Net Weight	Varies with length
Shipping Weight	Varies with length

Descriptive

System Configuration	Active 3-way
Component Loading	(2) 6.0" LF, (2) 3.5" Mid-bass, (1) AMT (Air Motion Transformer)
Input Configuration	3.5mm 4-pole phoenix
Enclosure Type	Three - way, sealed enclosures
Enclosure Materials	Aluminum, steel, Richlite ¹
Finish	Textured powdercoat - perforated metal grille ²
Suspension Hardware	3 - Axis wall mounting system included

¹ Requires factory preset
² Remote amplifier options available with factory presets loaded

¹ Richlite is a sustainable product used for trim elements on the Synergy 6 system, multiple colors and finishes available
² Standard color is black, custom colors are available upon request, upcharge will apply



Technical Drawings

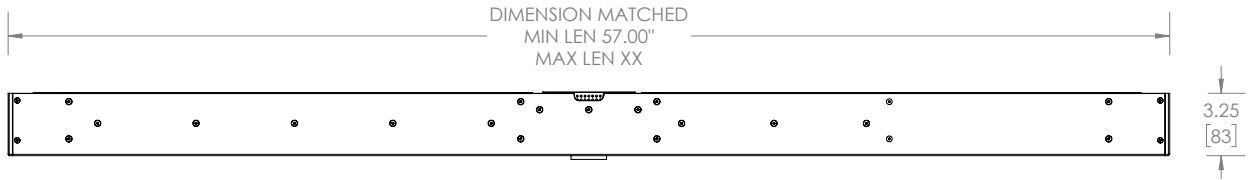

TOP VIEW
(SHOWN WHITHOUT OPTIONAL TRIM KIT)

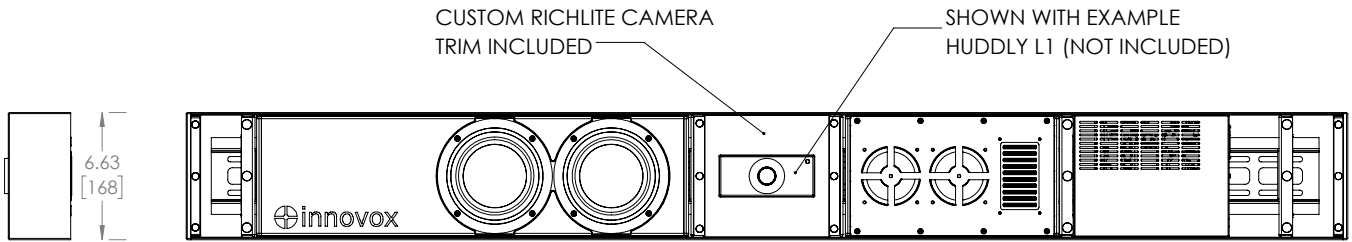

SIDE VIEW

FRONT VIEW
(SHOWN WITHOUT GRILLES)

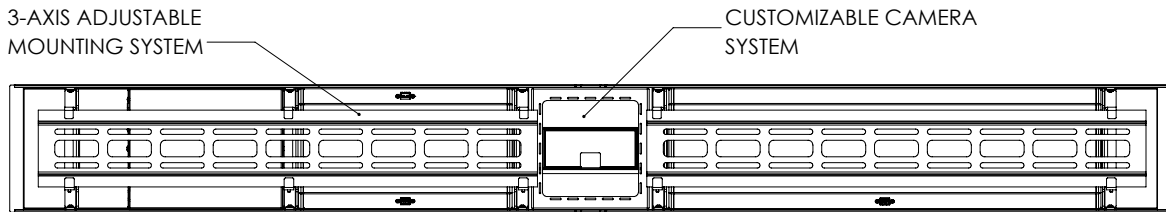

BACK VIEW

Accessories

SYNERGY 6 TRIM KIT
CUSTOM RICHLITE TRIM KIT
AVAILABLE IN MANY DIFFERENT FINISHES

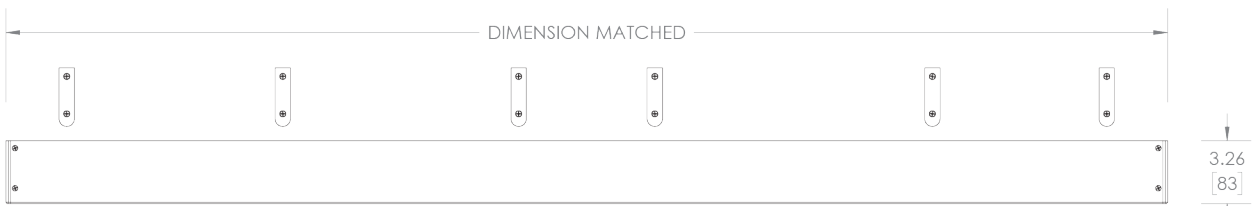

TOP VIEW



FRONT VIEW



Exploded View

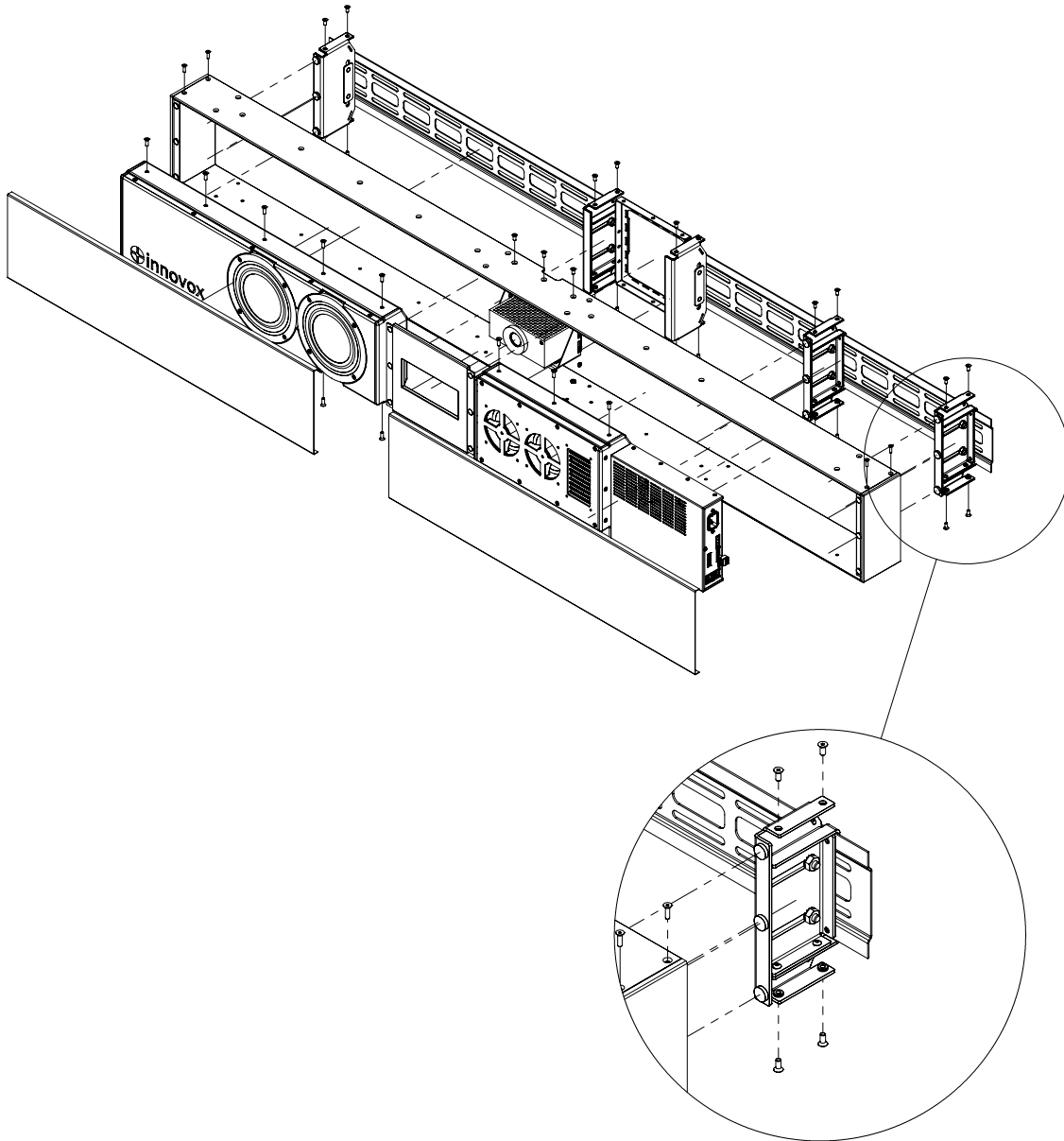

DETAIL : A
3 – Axis mounting system